

# Delock Keystone cover black with 9.7 mm hole 4 pieces

## Description

This Keystone cover by Delock can be used e.g. for mounting connectors. With its standardised dimensions it can be used for easy snap-in mounting in e.g. a Keystone patch panel, face plate or surface-mount box.

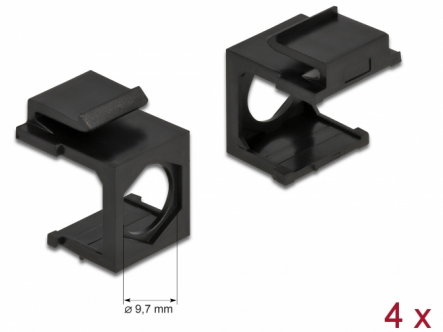

**Item no. 86739**

EAN: 4043619867394

Country of origin: Taiwan,  
Republic of China

Package: Zip poly bag

## Technical details

- For Keystone ports with 19.2 x 14.9 mm
- 9.7 mm hole
- Colour: black
- Dimensions (LxWxH): ca. 17.3 x 16.3 x 22.3 mm

## Package content

- 4 x Keystone cover

## Images



## General

Mounting type:	Keystone module
----------------	-----------------

## Physical characteristics

Housing colour:	black
Length:	17.3 mm
Width:	16.3 mm
Height:	22.3 mm